



Shenzhen OPIZ Electronics Co.,Ltd

WHO WE ARE?



OPIZ

Mission: Safety & Comfort

Original Professional Ideal Zeal

Shenzhen OPIZ Electronics CO., LTD, as a high-tech enterprises in China, integrate R&D, production, quality, sales and after-sales service together.

Establishing 38,000 square meters modern science and technology park, OPIZ introduced advanced technology, featured high technical capabilities. Our products are exported to worldwide and annual production capability is 500,000 pieces (sets) .

OPIZ has been focusing on research, development and innovation, striving to high standard "OPIZ" household intelligent terminal management system. More than ten years experience in supplying video door phone, we have been attracting domestic and foreign customers' consistent high praise and favors.

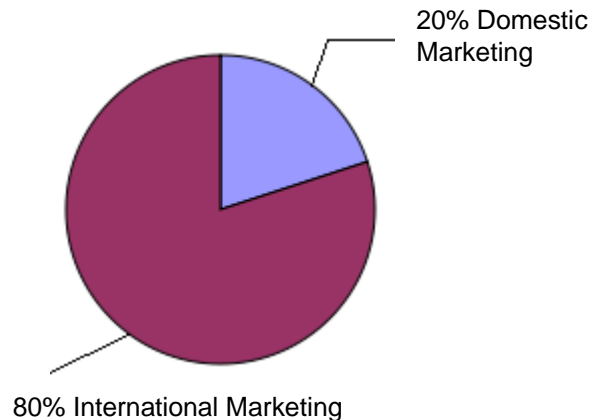

MILESTONES

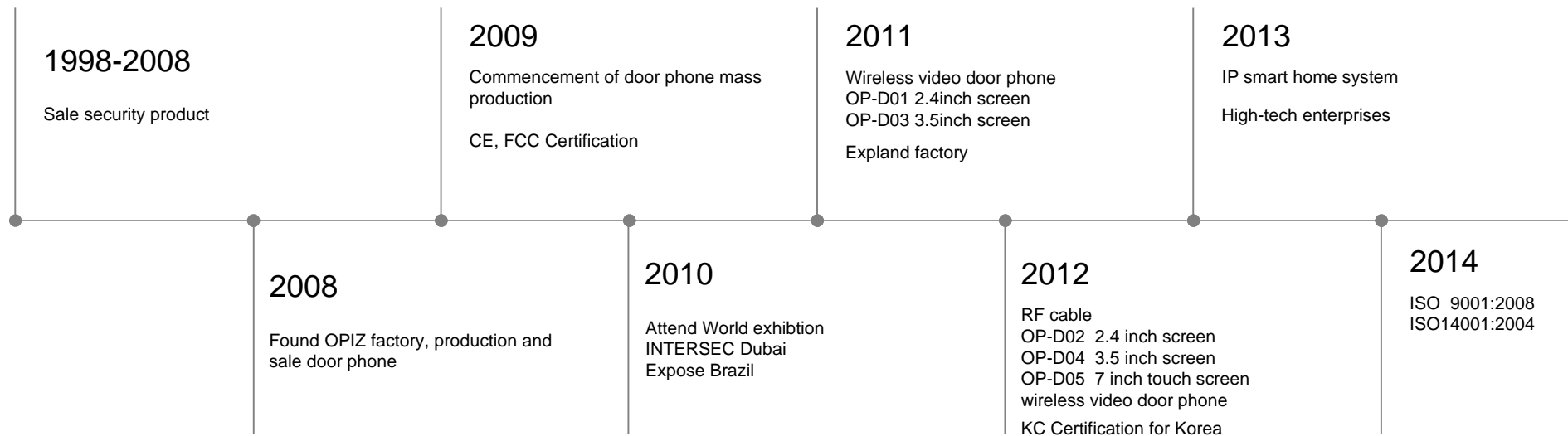

MARKET

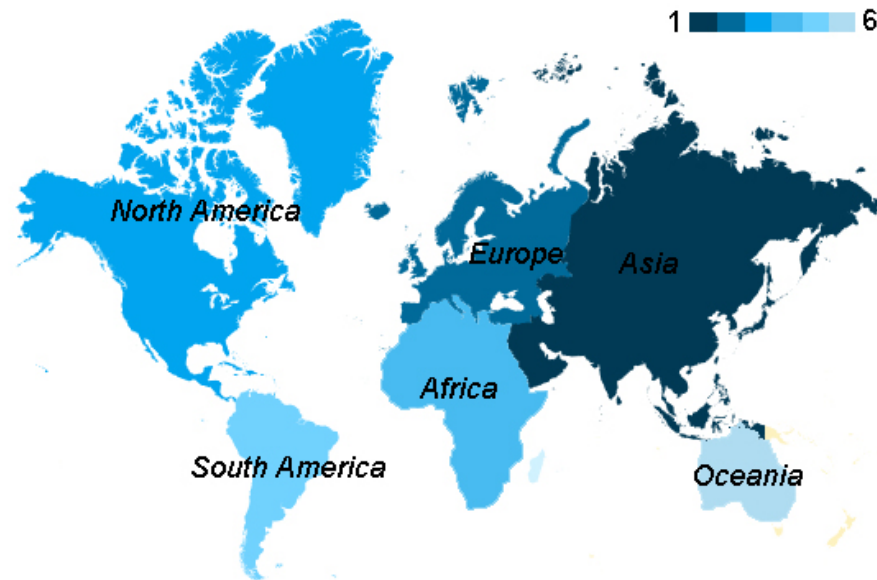

Cooperate with 100 countries.

Europe: France, England, Germany, Poland, Norway, Serbia, Montenegro, Romania, Russia

Middle East \ Asia: Saudi Arabia, UAE, Israel, Bangladesh, India, Singapore

Africa: Algeria, South Africa

Oceania: Australia

North America: United States, Canada

South America: Mexico, Brazil

GLOBAL EXPERTISE

2010

Security Essen Essen, Germany → Exposec Sao Paulo, Brazil → Intersec Dubai, UAE

2011

ISC WEST Las Vegas NV, USA → Safety & Security Asia Suntec, Singapore → Intersec Dubai, UAE → IFSEC Expo Birmingham, UK

2012

Intersec Dubai, UAE → ISC WEST Las Vegas NV, USA → IFSEC Expo Birmingham, UK → IFSEC INDIA Dew Delhi, India

2013

Intersec Dubai, UAE → MIPS Moscow, Russia → IFSEC Expo Birmingham, UK → IFSEC INDIA Dew Delhi, India

2014

Intersec Dubai, UAE → MIPS Moscow, Russia → IFSEC Expo London, UK

*

WWW.OPIZCN.COM

TRADE SHOWS

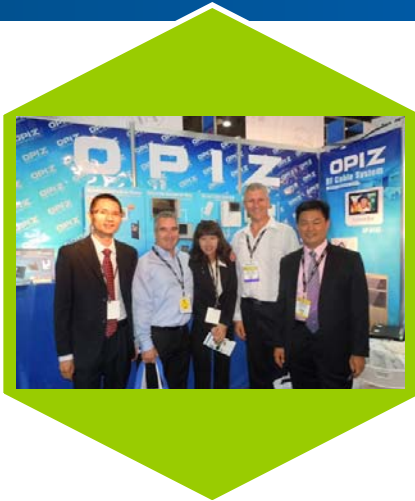

2012迪拜展会 Intersec 2012 Dubai, UAE



2012英国展会 IFSEC 2012 Birmingham, UK



2012西安安防展 2012 Xi'an security exhibition



COMPANY ORGANIZATIONAL STRUCTURE

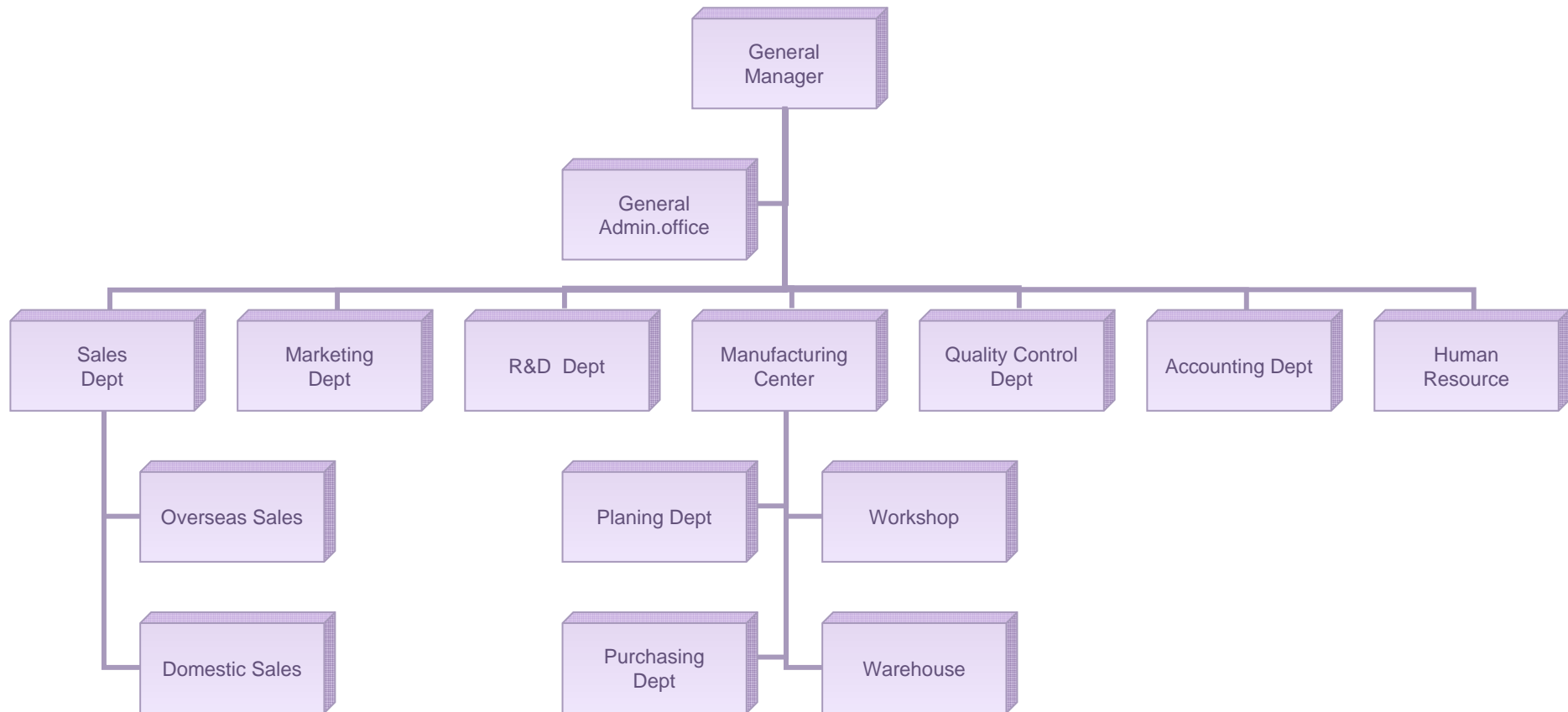

R&D

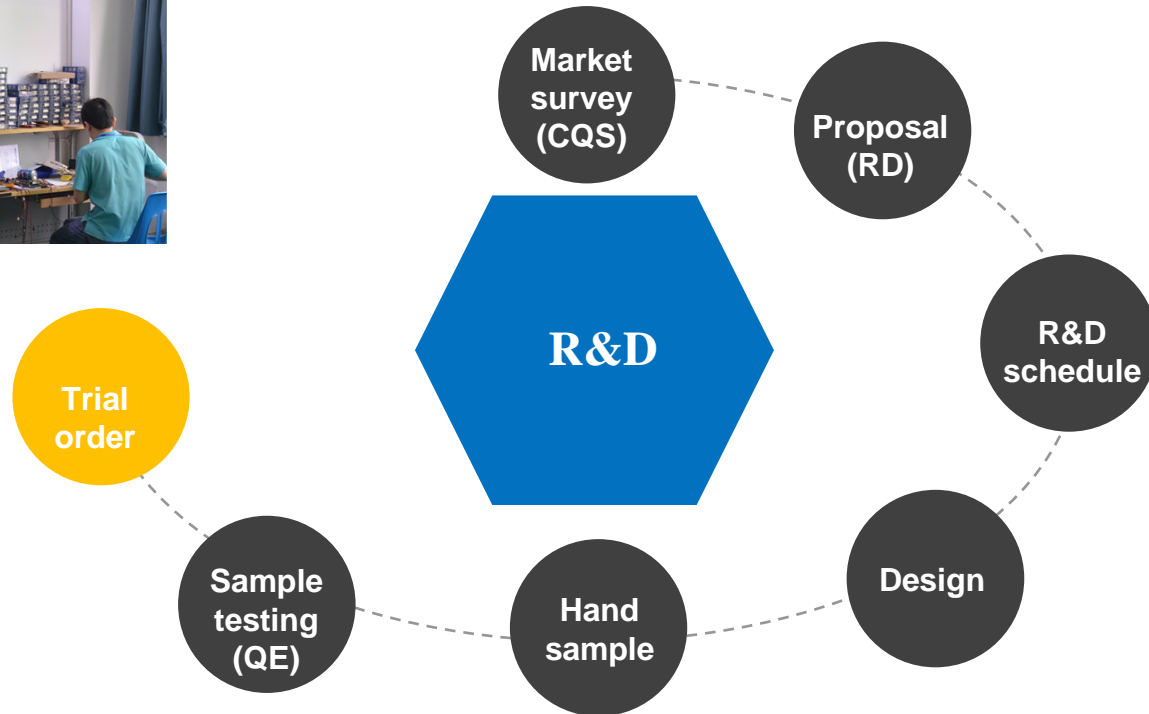

PRODUCTION PROCESS

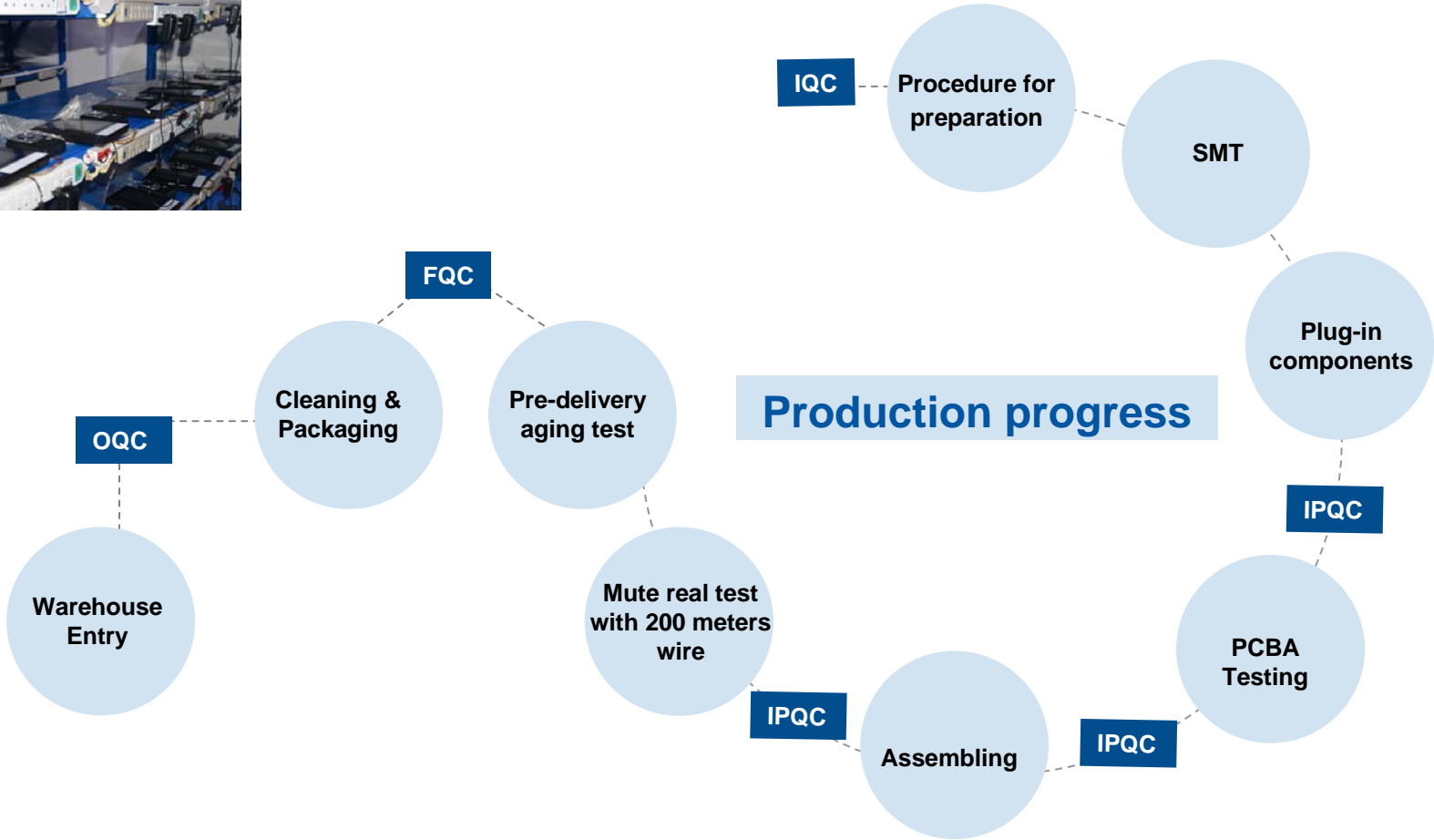

PRODUCTION WORKSHOP

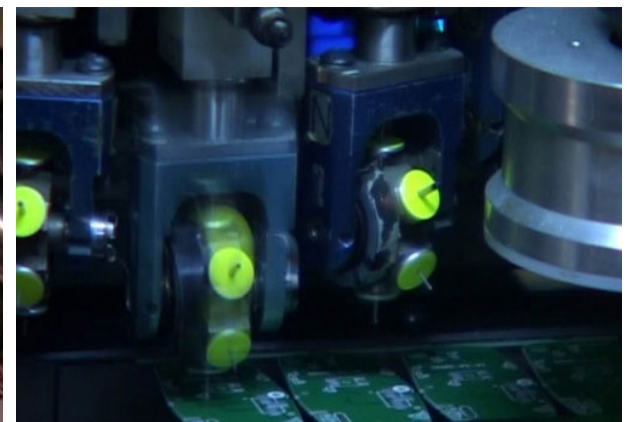
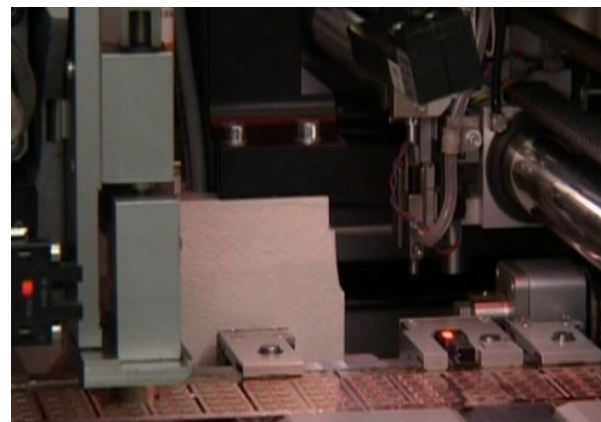
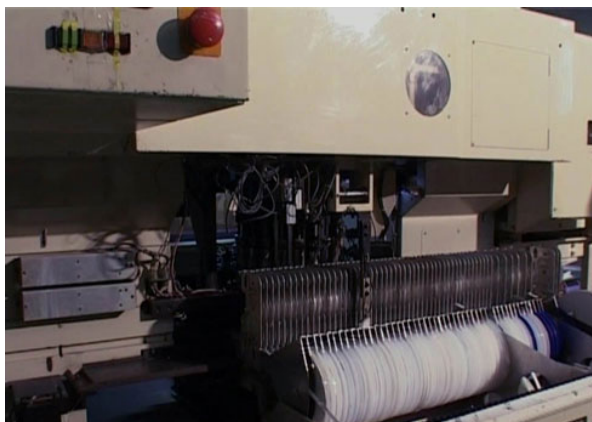

*

WWW.OPIZCN.COM

QC

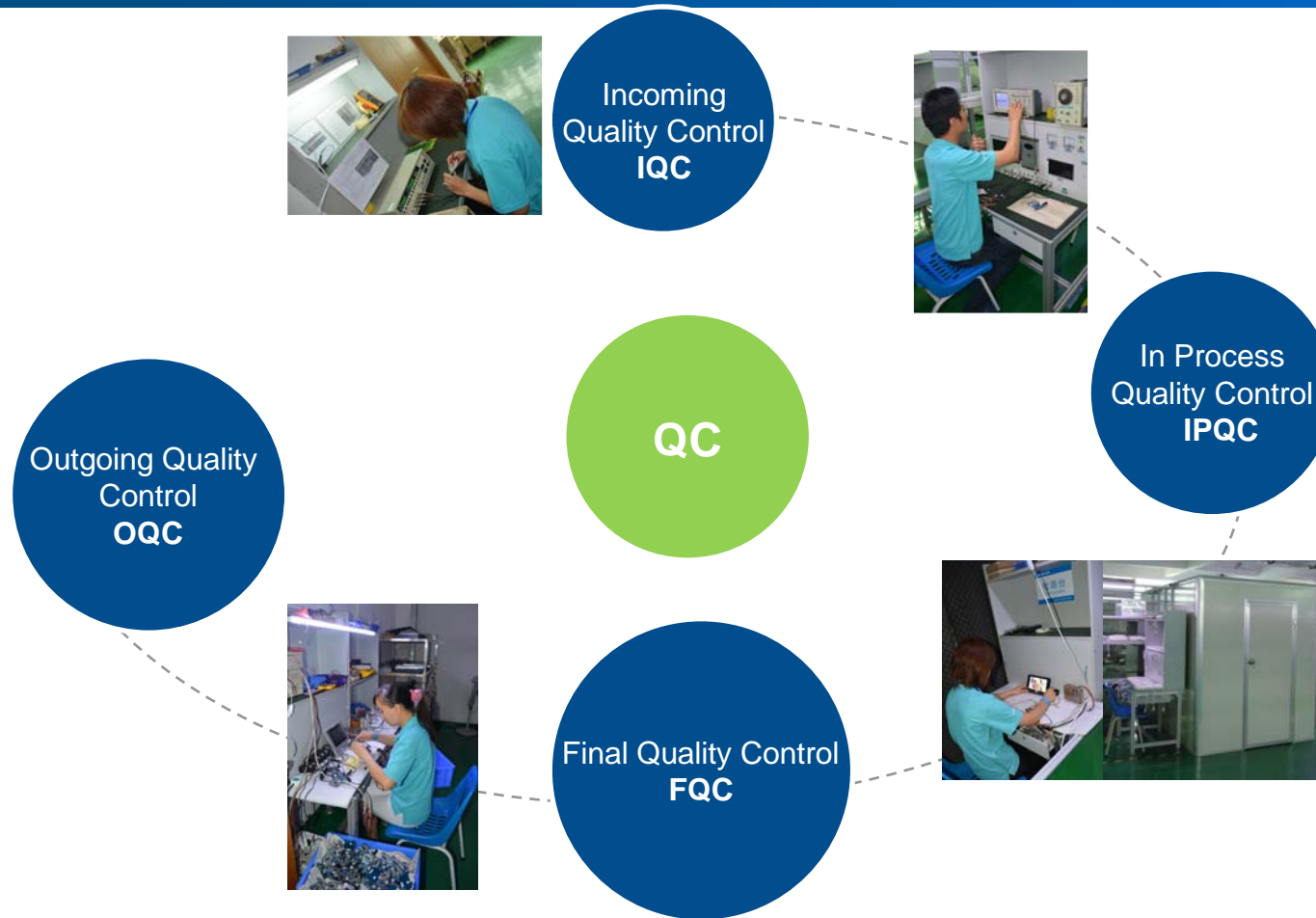

*

SERVICE AND WARRANTY



Warranty: 1 Year

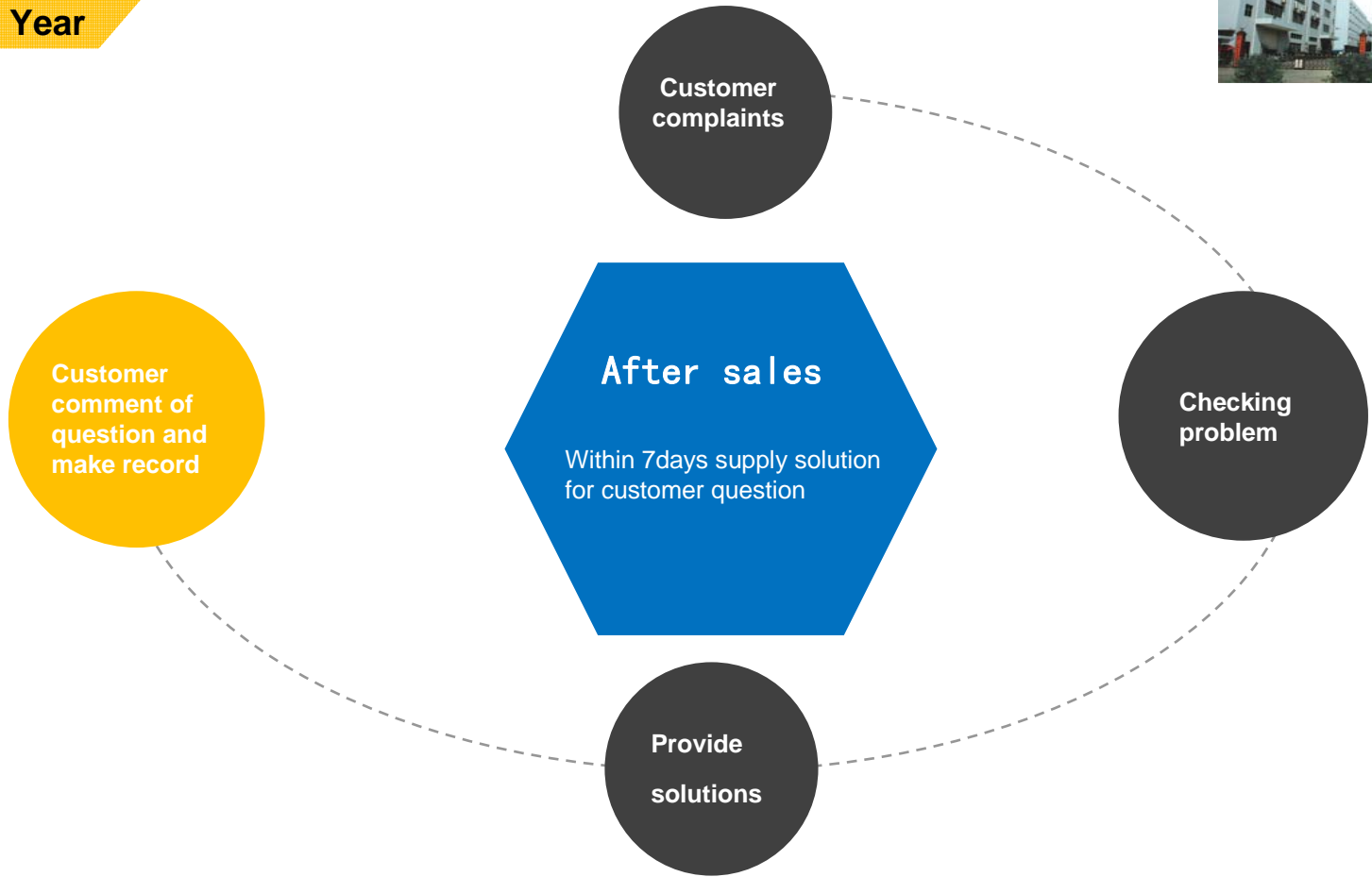

*

PRODUCT INSTRUCTION



- IP smart home system
- Wireless video door phone
- Villa system
- Direct call system
- Digital system

IP smart home system



- ❖ Adopt standard TCP/IP protocol for good signal.
- ❖ Video chat / message receiving and record
- ❖ Alarm and access control with ARM9 chip, DSP technology.
- ❖ Use Mobile phone and PC to control home appliance
- ❖ Standby and safe system with Linux software

Wireless video door phone



Product description:Working by 2.4G frequency

Indoor Monitor : OP-DA05

7 inch LCD touch screen with digital phone frame and MP3 function.

one 2 G SD card, can take photo and video

Visitor calling, video intercom, unlocking, monitoring

Monitor color: black and white

Music saved in SD card can be used as ringtones

Adjustable color,ring tone volume and intercom volume

English or French version for option

Table mounted and wall mounted

Max capability is 2 cameras with 3 monitors

Recharge lithium battery

Dimensions: 200 x 125 x 20mm

Outdoor camera:OP-D010

Water-proof camera

CMOS camera with night vision

Break off recharge -lithium battery

Wall mounted

Dimensions: 175 x 105 x 60mm



Villa system



- ❖ 4 wires simple wiring and easy installation
- ❖ Call, intercom, monitor, unlock
- ❖ One system 7 outdoor units with 4 indoor units
- ❖ All kinds outdoor unit can connect with any indoor unit
- ❖ One system compatible audio and video
- ❖ Video can be either B/W or Color

Wiring diagram:

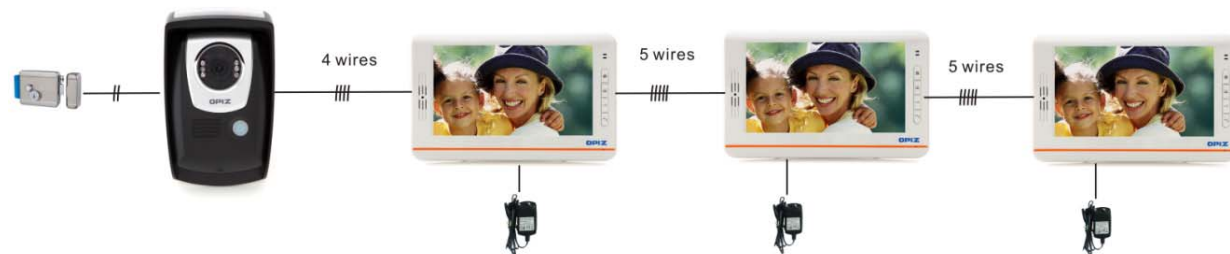

Apartment system



- ❖ 4 wires simple wiring and easy installation
- ❖ Call, intercom, monitor, unlock
- ❖ One button calls one room directly
- ❖ Capability: 2 to 32 units
- ❖ Name place for setting by self
- ❖ All kinds outdoor unit can connect with any indoor unit
- ❖ One system compatible audio and video
- ❖ Video can be either B/W or Color

Wiring diagram:

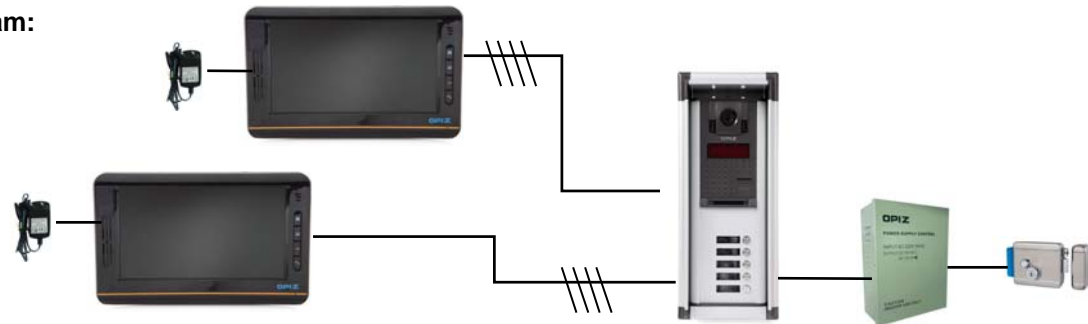

Digital system

Digital system

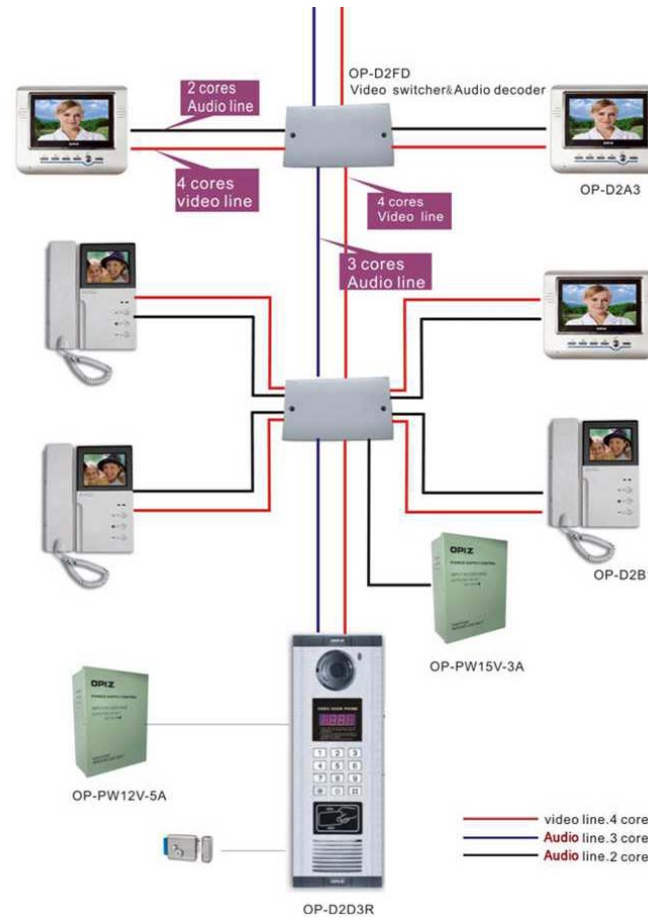

- ❖ Two way communication with indoor unit
- ❖ 90 pieces of passwords in maximum
- ❖ Unlock by ID card for option
- ❖ Back light for keyboard



OFFICE



CERTIFICATE

Certificate of Compliance

Certificate Number : BSTDG100278051318C-1

Applicant : SHENZHEN OPZ ELECTRONICS CO., LTD
Yuhong Industry Park, West Kingye RD., Baoan District, Shenzhen

Manufacturer : SHENZHEN OPZ ELECTRONICS CO., LTD
Yuhong Industry Park, West Kingye RD., Baoan District, Shenzhen

Product : VIDEO DOOR PHONE SYSTEM

Trade Name : OPZ

Model : OP-D103(OP-D1A3), OP-D001-100(OP-D0A81-100), OP-D001-100(OP-D1A81-100), OP-D001-100(OP-D2A81-100), OP-D001-100(OP-D3A81-100), OP-D001-100(OP-D4A81-100), OP-D001-100(OP-D5A81-100), OP-D101-100, OP-D201-100, OP-D301-100, OP-D401-100, OP-D501-100

Test Standard : EN60950-1:2006+A11:2007
EN61050-2:2006+A2:2008
EN61050-3:2008
EN60954-1:1998-A2:2003

The EUT described above has been tested by us with the listed standards and found in compliance with the Council EMC Directive 2004/105/EC. It is possible to use CE marking to demonstrate the compliance with this EMC Directive.

The certificate applies to the tested sample above mentioned only and shall not imply an assessment of the whole production. It is only valid in connection with the test report number: BSTDG100278051318B-1.

CE

Christina Manager
May 11, 2010

Shenzhen BST Technology Co., Ltd.
37 Hemei Technology Building No. 10, Haha Road, Science Park, Nanshan District, Shenzhen, Guangdong, China
Tel: 86-755-26477171-11 Fax: 86-755-26563432 http://www.opzcn.com

Certificate of Compliance

Certificate Number : BSTDG100278051318C-2

Applicant : SHENZHEN OPZ ELECTRONICS CO., LTD
Yuhong Industry Park, West Kingye RD., Baoan District, Shenzhen

Manufacturer : SHENZHEN OPZ ELECTRONICS CO., LTD
Yuhong Industry Park, West Kingye RD., Baoan District, Shenzhen

Product : VIDEO DOOR PHONE SYSTEM

Trade Name : OPZ

Model : OP-D103(OP-D1A3), OP-D001-100(OP-D0A81-100), OP-D001-100(OP-D1A81-100), OP-D001-100(OP-D2A81-100), OP-D001-100(OP-D3A81-100), OP-D001-100(OP-D4A81-100), OP-D001-100(OP-D5A81-100), OP-D101-100, OP-D201-100, OP-D301-100, OP-D401-100, OP-D501-100

Test Standard : EN 60950-1:2006+A11:2007

The EUT described above has been tested by us with the listed standards and found in compliance with the Council LVD Directive 2006/95/EC. It is possible to use CE marking to demonstrate the compliance with this LVD Directive.

The certificate applies to the tested sample above mentioned only and shall not imply an assessment of the whole production. It is only valid in connection with the test report number: BSTDG100278051318B-2.

CE

Christina Manager
May 11, 2010

Shenzhen BST Technology Co., Ltd.
37 Hemei Technology Building No. 10, Haha Road, Science Park, Nanshan District, Shenzhen, Guangdong, China
Tel: 86-755-26477171-11 Fax: 86-755-26563432 http://www.opzcn.com

FCC VERIFICATION OF CONFORMITY

BSTDG1006900237C-3

We herewith confirm the following designated product:

VIDEO DOOR PHONE SYSTEM
Trade Name: OPZ
MODEL NO.: OP-D103(OP-D1A3), OP-D001-100(OP-D0A81-100), OP-D001-100(OP-D1A81-100), OP-D001-100(OP-D2A81-100), OP-D001-100(OP-D3A81-100), OP-D001-100(OP-D4A81-100), OP-D001-100(OP-D5A81-100), OP-D101-100, OP-D201-100, OP-D301-100, OP-D401-100, OP-D501-100

Product Identification:

This device complies with Part 15 of the FCC rules operation is subject to the following two conditions:
(1) this device may not cause harmful interference, and
(2) this device must accept any interference received, including interference that may cause undesired operation.

(Identification of regulatory jurisdiction)

This declaration is the responsibility of the manufacturer/importer.

SHENZHEN OPZ ELECTRONICS CO., LTD.
Yuhong Industry Park, Kingye West RD., Shajing, Baoan District, Shenzhen
(Home Address)

MANUFACTURER / IMPORTER: SHENZHEN OPZ ELECTRONICS CO., LTD.

TEST LABORATORY: Shenzhen BST Technology Co., Ltd.

Christina Manager
Aug 26, 2010

Shenzhen BST Technology Co., Ltd.
37 Hemei Technology Building No. 10, Haha Road, Science Park, Nanshan District, Shenzhen, Guangdong, China
Tel: 86-755-26477171-11 Fax: 86-755-26563432 http://www.opzcn.com

FC

CERTIFICATE OF CONFORMITY

Shenzhen Toby Technology Co., Ltd.
10/F, A Block, Jinta H & S Bldg, No. 8 Songgangshan Road, Science & Technology Park, Nanshan District, Shenzhen, China

No.: TB1008028

Applicant : SHENZHEN OPZ ELECTRONICS CO., LTD
Address : Yuhong Industry Park, Kingye West RD., Shajing, Baoan District, Shenzhen, China

Manufacturer : SHENZHEN OPZ ELECTRONICS CO., LTD
Address : Yuhong Industry Park, Kingye West RD., Shajing, Baoan District, Shenzhen, China

Product : Wireless Video Door Phone

Models : OP-D03, OP-D0X ('X' is the number from 1 to 9)

Test Standards: ETSI EN 301 489-1 V1.8.1: 2008;
ETSI EN 301 489-17 V1.3.2: 2008;
ETSI EN 300 328 V1.7.1: 2006;
EN 60371: 2002;
EN 60950-1: 2006+A11: 2009.

The EUT described above has been tested by us with the listed standards and found in compliance with the Council R&TTE Directive 1999/5/EC. It is possible to use CE marking to demonstrate the compliance with this R&TTE Directive.

The certificate applies to the tested sample above mentioned only and shall not imply an assessment of the whole production. It is only valid in connection with the test report TB-EMC107789, TB-RF107790, TB-RF107791, TB-HEA107792 and TB-LVD107793.

CE

Justin Zhang Manager
Oct 22, 2010

Shenzhen Toby Technology Co., Ltd.
10/F, A Block, Jinta H & S Bldg, No. 8 Songgangshan Road, Science & Technology Park, Nanshan District, Shenzhen, China
Tel: 86-755-26477171-11 Fax: 86-755-26563432 http://www.opzcn.com

DECLARATION OF CONFORMITY

Shenzhen Toby Technology Co., Ltd.
10/F, A Block, Jinta H & S Bldg, No. 8 Songgangshan Road, Science & Technology Park, Nanshan District, Shenzhen, China

No.: TB1008312

Applicant : SHENZHEN OPZ ELECTRONICS CO., LTD
Address : Yuhong Industry Park, Kingye West RD., Shajing, Baoan District, Shenzhen, China

Manufacturer : SHENZHEN OPZ ELECTRONICS CO., LTD
Address : Yuhong Industry Park, Kingye West RD., Shajing, Baoan District, Shenzhen, China

Product : Wireless Video Door Phone

Models : OP-D03, OP-D0X('X' is 1-9)

Test Standards: 2002/95/EC;
2006/95/EC;
IEC 62321-2:2008.

The EUT described above has been examined by us with the listed standards and found in compliance with the Directive 2002/95/EC and Directive 2006/95/EC. It is possible to use RoHS marking to demonstrate the compliance with this RoHS Directive.

The test data obtained and the report issued by laboratories other than TOBY are provided by the applicant to us for data consolidation purpose. The report shall not be reproduced in part without written approval of us. It is only valid in connection with the test report number: TB-RoHS107809.

RoHS

Justin Zhang Manager
Aug 30, 2010

Shenzhen Toby Technology Co., Ltd.
10/F, A Block, Jinta H & S Bldg, No. 8 Songgangshan Road, Science & Technology Park, Nanshan District, Shenzhen, China
Tel: 86-755-26477171-11 Fax: 86-755-26563432 http://www.opzcn.com



CERTIFICATE

sira

CERTIFICATION

QUALITY MANAGEMENT SYSTEM CERTIFICATE

This is to Certify that the QUALITY MANAGEMENT SYSTEM of

SHENZHEN OPIZ ELECTRONICS CO.,LTD.

2/F, 3/F, Block B3, Zone B, Yuhong Industrial Park, Heyi Community,
Shajing Subdistrict, Bao'an District, Shenzhen, Guangdong, China

has been assessed by Sira Certification Service
and found to comply with

GB/T19001-2008 idt ISO9001:2008

for the

Technological development, manufacture and sales of building
intercom products (visual, non-visual)

Certificate No: 143834
Initial Certification: 18 April 2014
Date of Issue/Reissue: 18 April 2014
Certificate Expiry: 9 April 2015



On behalf of SCS



011



Recertification Date: 9 April 2017

This certificate is subject to the company maintaining its system to the required standards, which will be monitored by Sira.
The use of this Certificate and the Sira Certification Mark are subject to the Regulations Applicable to Holders of Sira Certificates.

Sira Certification Service

This certificate is the property of Sira and shall be returned when requested. It may only be reproduced in its entirety and without change.
Rake Lane, Eccleston, Chester, CH4 9JN, England Email: info@sira.com.cn

sira

CERTIFICATION

ENVIRONMENTAL MANAGEMENT SYSTEM CERTIFICATE

This is to Certify that the ENVIRONMENTAL MANAGEMENT SYSTEM of

SHENZHEN OPIZ ELECTRONICS CO.,LTD.

2/F, 3/F, Block B3, Zone B, Yuhong Industrial Park, Heyi Community,
Shajing Subdistrict, Bao'an District, Shenzhen, Guangdong, China

has been assessed by Sira Certification Service
and found to comply with

GB/T24001-2004 idt ISO14001:2004

for the

Technological development, manufacture and sales of building
intercom products (visual, non-visual)

Certificate No: 143833
Initial Certification: 18 April 2014
Date of Issue/Reissue: 18 April 2014
Certificate Expiry: 9 April 2015



Certification Manager

Recertification Date: 9 April 2017

This certificate is subject to the company maintaining its system to the required standards, which will be monitored by Sira.
The use of this Certificate and the Sira Certification Mark are subject to the Regulations Applicable to Holders of Sira Certificates.

Sira Certification Service

This certificate is the property of Sira and shall be returned when requested. It may only be reproduced in its entirety and without change.
Rake Lane, Eccleston, Chester, CH4 9JN, England Email: info@sira.com.cn
G-1, 12/F, No.2009 Pudong Ave., Pudong New Area, Shanghai, P. R. China



WWW.OPIZCN.COM

WWW.OPIZCN.COM



Thank you!

Address: Yuhong Area Xingye West Road Shajing Bao'an Shenzhen China

Tel : 0086-0755-81499811 Fax : 0086-0755-81499511

WWW.OPIZCN.COM